



3651 N. Hwy. 89 • Chino Valley, AZ 86323  
(928) 636-7080 • www.p-a-g.net

## NISSAN XTERRA 2WD/4WD INSTALLATION INSTRUCTIONS 2000 KIT #40013

### ⚠WARNING

Installation of a Performance Accessories body lift will change the center of gravity and the handling characteristics of the vehicle. Because of the higher center of gravity and larger tires, the vehicle will handle and react differently both on and off road. You must drive it safely! Extreme care must be taken to prevent vehicle rollover or loss of control, which could result in serious injury or death. Avoid sudden sharp turns or abrupt maneuvers and always make sure all vehicle occupants have their seat belts fastened.

### ⚠WARNING

Read and understand all instructions, warnings, cautions, and notes in this sheet and in your owners manual before you begin the installation of this body lift kit.

### ⚠CAUTION

Proper installation of a Performance Accessories body lift kit requires knowledge of the factory recommended procedures for disassembly and assembly of original equipment components. We recommend that the factory shop manual and any special tools necessary to your vehicle be on hand during the installation. Installation of this body lift kit without proper knowledge of the factory recommended procedures may affect the performance of these components and the safety of your vehicle. We strongly recommend that a certified mechanic familiar with the installation of similar components install this body lift kit.

### ⚠WARNING

This body lift kit should only be installed on vehicles in good working condition. Before installation, the vehicle should be thoroughly inspected for evidence of corrosion or deformation of the sheet metal around the factory body mounts. This body lift kit should not be installed on any vehicle that is suspected to have been in a collision or misused. Off road use of your vehicle with this body lift installed may increase the stress applied to the factory body mounts. We do not recommend that any vehicle with a body lift installed be involved in any extreme off road maneuvers such as jumping. Failure to observe this warning may result in serious personal injury and/or severe damage to your vehicle

### ⚠WARNING

Performance Accessories strongly discourages the use of a suspension lift kit or any other lift device in addition to a body lift kit. A vehicle that uses a combination of lift devices not originally engineered to be used together may result in unexpected and unsafe handling characteristics. Many states now have laws restricting bumper heights and vehicle lifts. Local laws should be consulted to determine if the changes you intend to make to your vehicle comply with state laws.

### ⚠WARNING

The installation of larger wheel and tire combinations may reduce the effectiveness of the Anti-lock Braking System.

### ⚠WARNING

Always wear eye protection when operating power tools.

### ⚠WARNING

Ensure that your vehicle tires are properly blocked and secured before you begin installation of this lift kit.

### ⚠NOTE

Performance Accessories recommends using the Loctite® supplied in the kit on all hardware unless noted in the instructions.

### ⚠NOTE

You will find it easier to keep track of hardware if immediately after removal you put the fasteners for each sub-assembly in a paper lunch bag and write on the bag where they go.

## A. Before you start.

### NOTE

As you read through this procedure, note that each part referenced has the same callout number throughout. Also, the part number in the text matches the corresponding part number in the art. Kit parts are prefaced by the word *kit* in italics.

1. Read all warnings and instructions completely and carefully before you begin.
2. Check to make sure the kit is complete (refer to the Parts List, section E).
3. Only install this kit on the vehicle for which it is intended. If anytime during the installation you encounter something different from what is outlined in the instructions, call technical support at (520) 636-0979.
4. Park the vehicle on a clean, dry, flat, level surface and block the tires so the vehicle cannot roll in either direction.
5. Disconnect both battery cables. Disconnect the negative cable (1) first, then the positive cable (2). Remove battery (3) from vehicle (refer to the owner's manual).

### WARNING

The Supplemental Restraint System (SRS, or air bag) must be deactivated during lift kit installation to avoid accidental air bag deployment while working near SRS sensors and wiring. Do not allow anyone near the air bag during lift kit installation. Accidental deployment can result in serious personal injury or death. Refer to your factory service manual/owner's manual for the recommended procedure to disable the SRS. The SRS must be reactivated before driving the vehicle.

6. Remove the air bag fuse (4) from the fuse box (5) (see the owner's manual for fuse location).

## B. Get ready to install the kit.

1. Remove the air cleaner assembly.
  - a. Cut zip tie (6).
  - b. Loosen four clips (7).
  - c. Tag, mark, and remove vacuum line (8) from air duct (9).
  - d. Loosen four clamps (10, 11 and 12) and remove the air duct (9) and air cleaner (13) from the throttle body (14) and the intake (15).

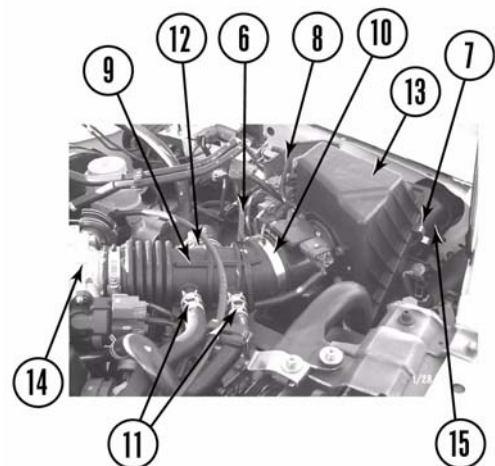
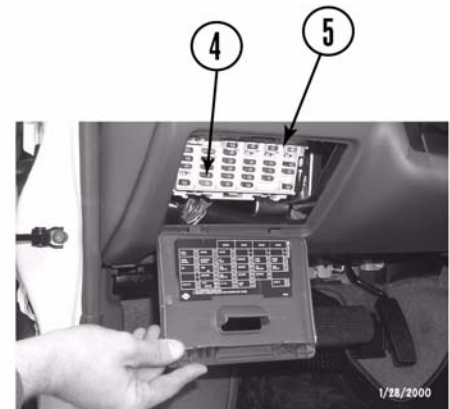
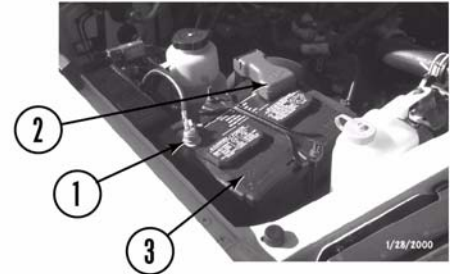

**⚠WARNING**

Ensure steering shaft does not turn independently of the steering gearbox. This could cause the air bag to malfunction. Accidental deployment can result in serious personal injury or death, or damage to the vehicle.

2. Remove the steering shaft.
  - a. To ensure proper steering alignment when kit steering extension is installed, mark the steering shaft (16) where it slides into the upper coupler (17).
  - b. Mark the lower coupler (18) and gearbox (19) where the steering shaft (16) slides onto gearbox splined shaft (20).
3. Remove bolt (21) from the steering shaft (16) and the upper coupler (17).
4. Remove bolt (22) from the steering shaft (16) and the gearbox splined shaft (20).
5. Slide the steering shaft (16) up and off the gearbox splined shaft (20), then out of the upper coupler (17). Remove the steering shaft (16) from the vehicle.

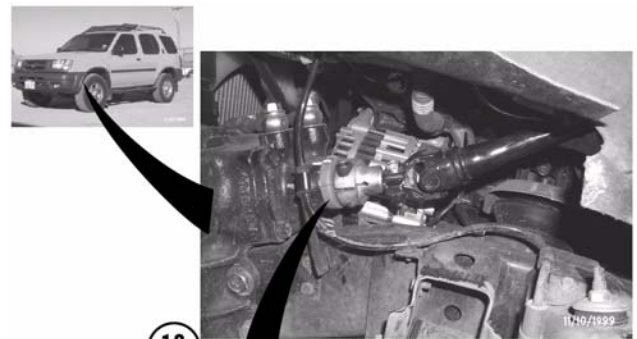
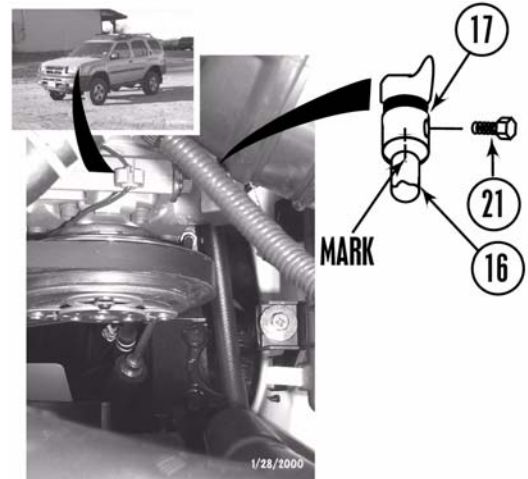
**⚠WARNING**

Use extreme caution when working with the engine cooling system. Never remove the radiator cap from a hot radiator or serious burns can result. Wait until the engine and radiator has cooled and there is no pressure in the system.

Coolant contains antifreeze. Store drained coolant away from children and animals. Coolant can be fatal if swallowed.

Do not spill coolant while draining system. Coolant is harmful to the environment.

6. Remove the radiator.
  - a. Remove six panel clips (23) and rubber flap (24) from frame (25).
  - b. If present on your vehicle, remove six bolts (26), two panel clips (27), and skid plate (28) from frame (25). If not present go to step A. 6. c. below.
  - c. Ensure radiator (29) has cooled enough to safely open the cooling system. Completely drain radiator into a clean container (refer to the owner's manual).
  - d. Loosen clamp (30) and remove the lower radiator hose (31) from the radiator (29).

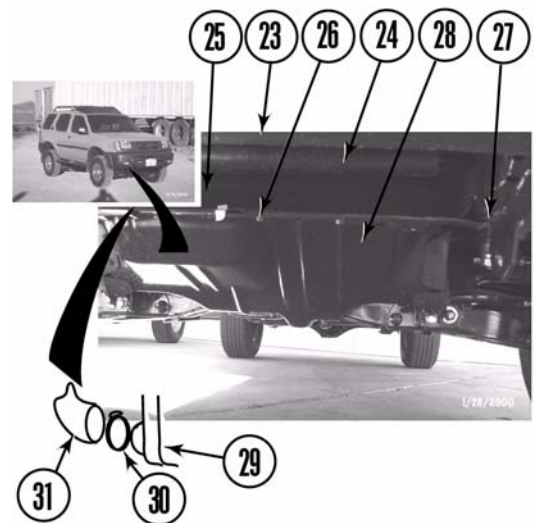

e. Loosen clamp (32) and remove the upper radiator hose (33) from the radiator (29).

f. Loosen clamp (34), remove two bolts (35) and the overflow bottle (36) from the core support (37).

g. Remove screw (38), lockwasher (39), washer (40), and the intake damper (41) from the core support (37).

h. Remove four bolts (42) from the fan shroud (43) and the radiator (29).

i. Remove two locknuts (44) and the two top radiator mounts (45) from the core support (37).

j. Lay fan shroud (43) against the engine and remove the radiator (29) up and out of the lower radiator support (46).

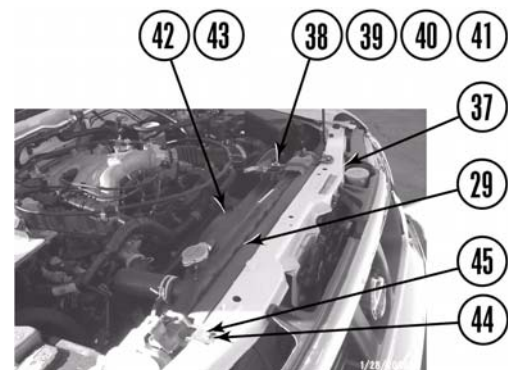
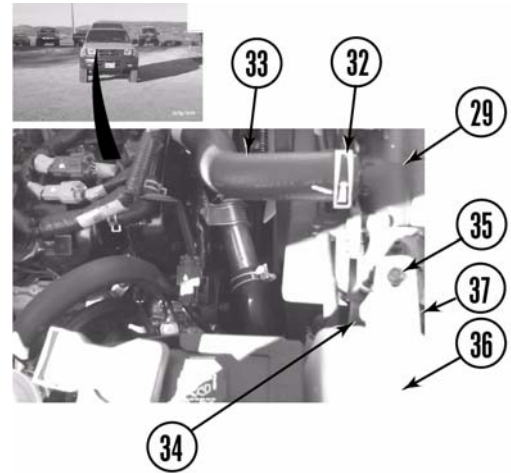

7. Loosen two clamps (47) and remove the heater hoses (48) from the heater core (49) to permit lifting.

8. Remove two bolts (50) and position the a/c hose (51) away from the firewall (52).

9. Reposition the power steering reservoir.

a. Remove three bolts (53), six washers (54) three grommets (55), bracket (56), and the power steering reservoir (57) from the passenger side front wheel well (58).

b. Install *kit* extension bracket (59) on the wheel well (58) with three grommets (55), six washers (54), and three bolts (53).

c. Install bracket (56) and power steering reservoir (57) on *kit* extension bracket (59) with three *kit* 1/4" x 1" bolts (60), six *kit* 1/4" washers (61), and three *kit* 1/4" nylock nuts (62).

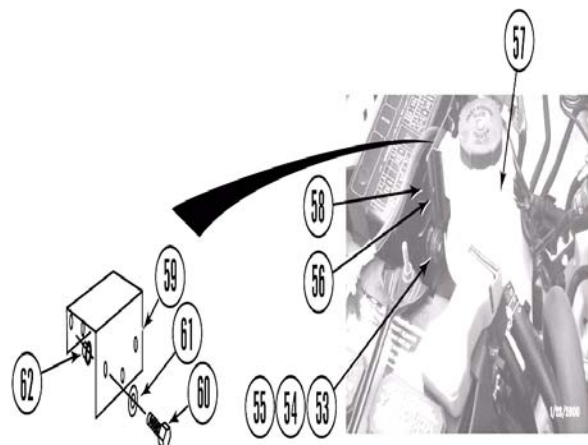
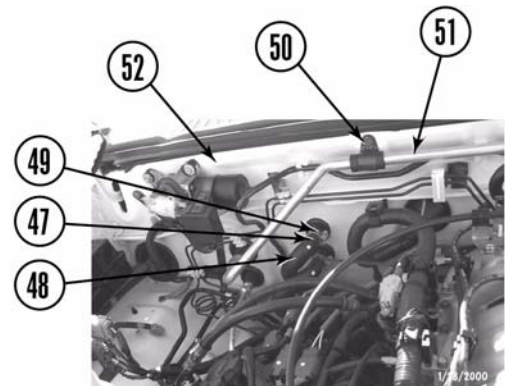

10. Remove the brake lines and vacuum lines.

- a. Remove two screws (63) and the line guard (64) from the passenger side of the frame (25).
- b. Remove four screws (65), brackets (66), the brake line (67) and the three vacuum lines (68) from the passenger side frame rail (25).
- c. Check along the passenger side frame rail (25) and inside the engine compartment to ensure there is enough slack to allow lifting. Disconnect the lines as necessary.

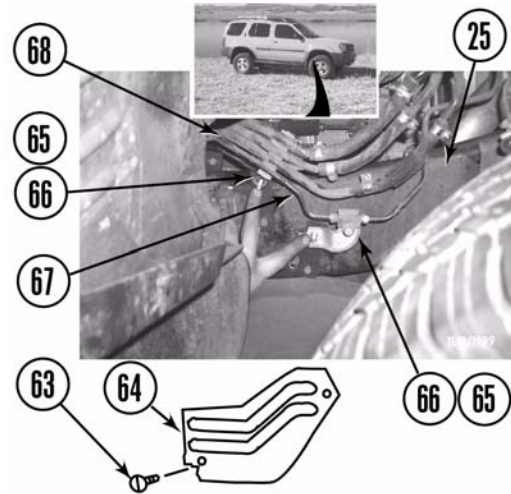

11. Remove two bolts (69), washers (70), and the body safety loop (71) from the floorboard (72).

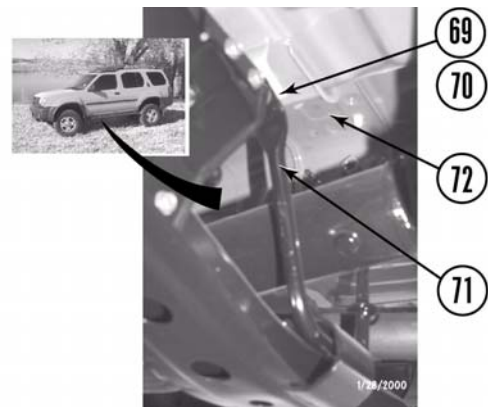

12. Remove the front bumper.

- a. If present on your vehicle, disconnect two wire harness connectors (73) from the two driving lights (74).

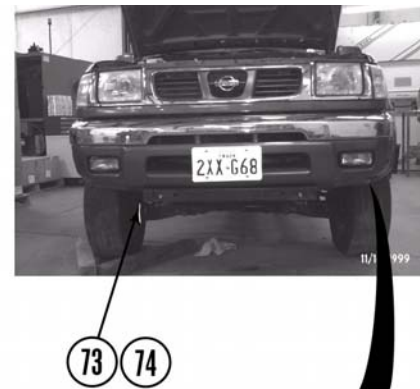

- b. Remove two bolts (75) and separate the two front bumper supports (76) from the frame (25).

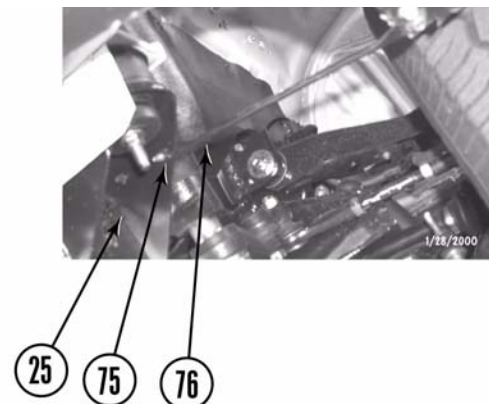

c. Remove two bolts (77) from the front bumper (78) and the front fenders (79).

d. Remove four bolts (80), washers (81), and the front bumper (78) from the frame (25).

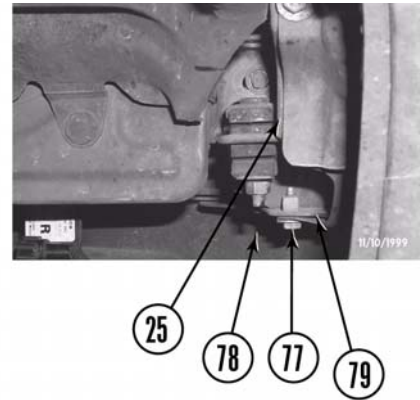

13. Remove four panel clips (82) and separate two wheel well flaps (83) from the frame (25).

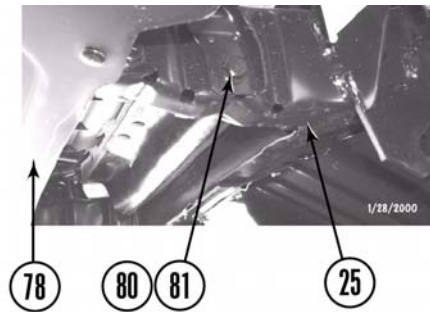

14. Remove transmission and transfer case shift levers.

**NOTE**  
If the vehicle has a manual transmission, ensure transmission is in neutral.

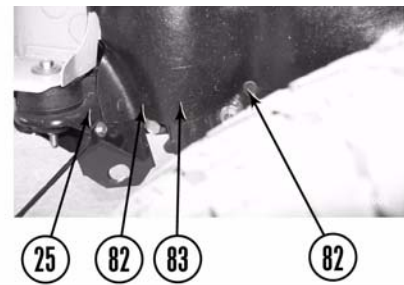

a. Remove 12 screws (84) and four scuff plates (85 and 86) from the door jambs (87) on both sides of the body (88).

b. Remove two bolts (89) and pop kick panels (90) from floorboard (72).

c. Remove four screws (91) and the console cover (92) from the floorboard (72). Pull the shift boot (93) back to expose the top of the transmission (94).

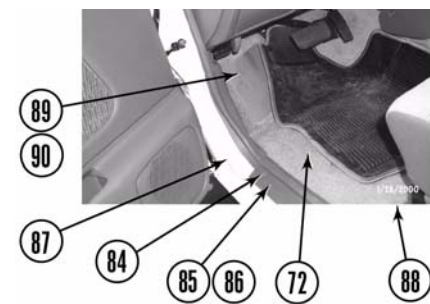

**NOTE**  
Wrap rags around the transmission shift lever base and the transfer case shift lever base immediately after unbolting to avoid dripping transmission fluid on vehicle carpet.

d. Remove c-clip (95), spacer (96), and the transmission shift lever (97) from the transmission (94).

e. If vehicle is 4WD, remove bolt (98) and the transfer case shift lever (99) from the transfer case (100).

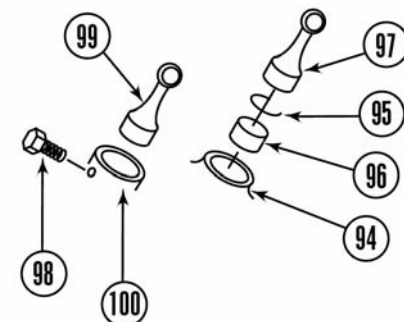

15. Remove the rear bumper.

a. Disconnect two license plate lights (101) from rear bumper (102).

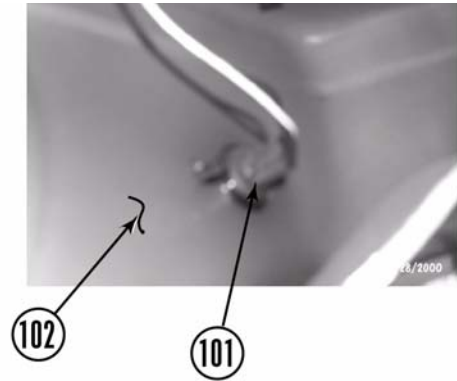
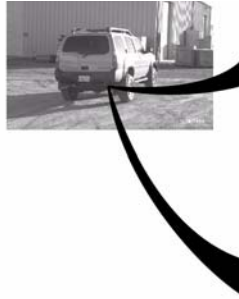

b. Remove six nuts (103), bolts (104), lockwashers (105), and the rear bumper (102) from the frame (25).

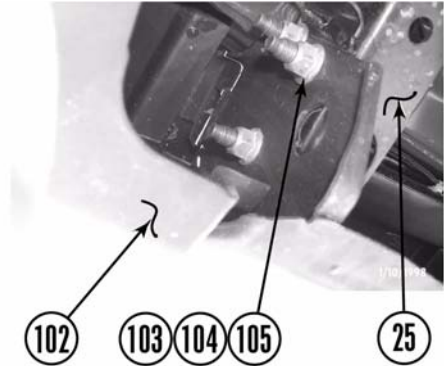

16. Prepare to lift body from frame.

a. Remove seven panel clips (106) and the filler hose guard (107) from the passenger side rear wheel well (108).

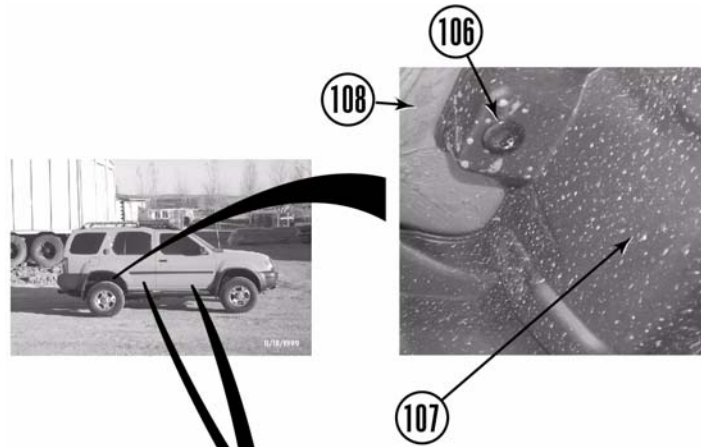

b. Pull four releases (109) and remove the rear seat base (110) from floorboard (72).

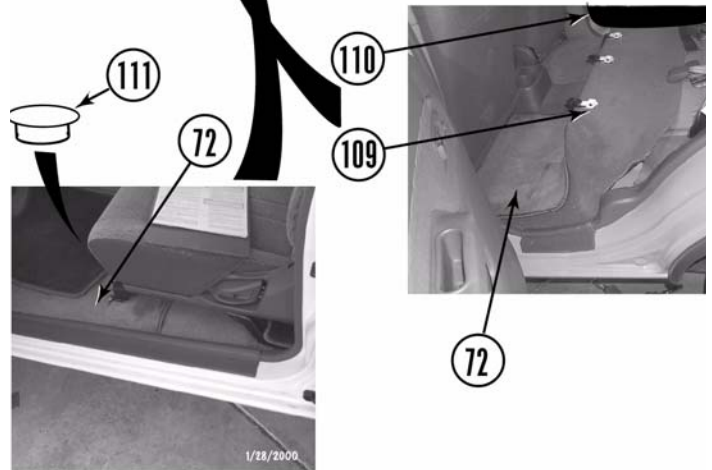

c. Pull the carpet and mat back to expose the two body mounting bolt access covers (111). Remove the access covers from the floorboard (72). Discard access covers.

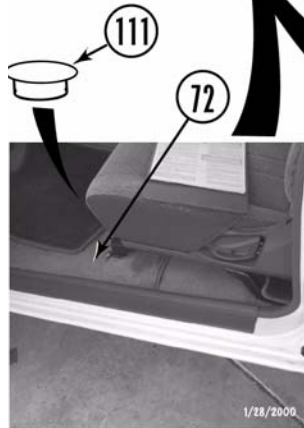

17. Lift the body.

a. Remove four bolts (112), washers (113), lockwashers (114), and two outside support brackets (115) from the body (88) and the frame (25).

b. Loosen but do not remove ten body mounting nuts (116) and bolts (117).

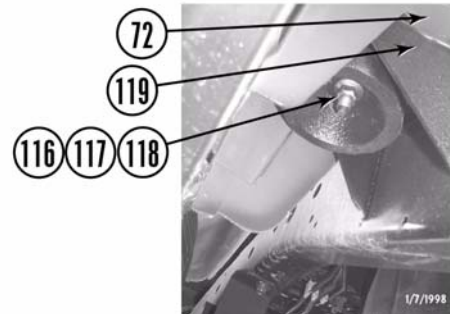
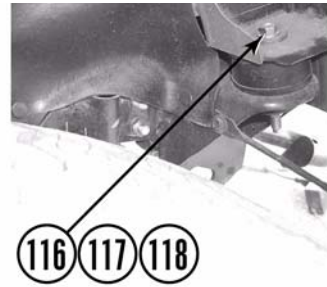

**C. Install the kit.**

**⚠WARNING**

Failure to replace the OEM body mounting hardware (except mounting bolts in the kit) in the stock locations could result in serious personal injury or damage to the vehicle.

1. Install the body passenger side spacer blocks.

**⚠WARNING**

Use extreme caution when lifting body from frame. Ensure lifting device is securely placed. Keep hands out from between frame and body, or serious personal injury could result.

**⚠CAUTION**

Continually check hoses, wires, etc. to be sure that everything is flexing properly and not binding, or damage to the vehicle could result. Be especially careful of the a/c hose at the firewall, the belt pulley, and at the core support.

**⚠NOTE**

Ensure stock spacers and body mounting pads stay on vehicle unless otherwise specified in these instructions. Kit spacer blocks are installed in addition to the stock spacers and body mounting pads.

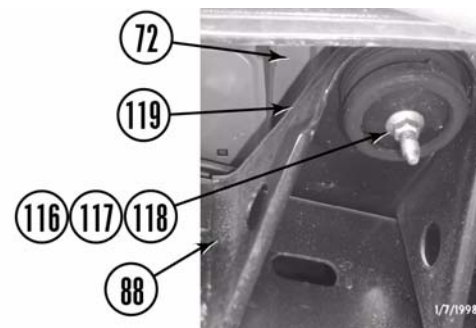
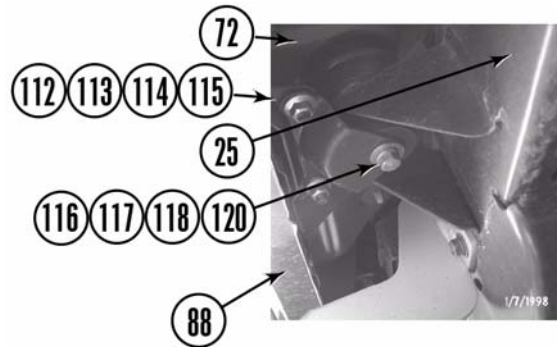

a. Remove nut (116), bolt (117), and washer (118) from the core support frame mounting pad (119).

b. Remove four nuts (116), bolts (117), washers (118), and lockwasher (120) from the floorboard (72) and body mounting pads (119). Outside support bracket (115) will come off with middle bolt (117).

c. Using a hydraulic jack and a wooden block, slowly lift the body (88) passenger side just high enough to position the *kit* spacer blocks (121) on the frame mounting pads (119).

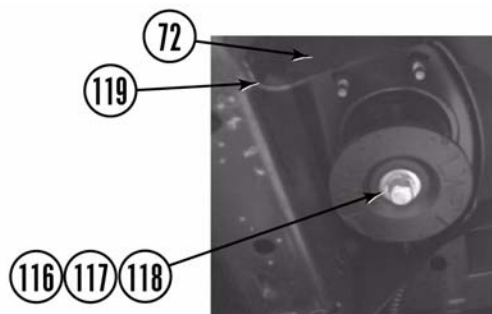



d. Position five *kit* spacer blocks (121) on top of the passenger side core support frame and floorboard mounting pads (119).

e. Install a *kit* 7/16" x 7" bolt (122), a *kit* 3/8" washer (123), and a *kit* nylock nut (124) in the core support mounting pad (119). Do not tighten.

f. Install a *kit* 7/16" x 7" bolt (122), a *kit* 3/8" washer (123), and a *kit* nylock nut (124) the next mounting pad (119). Do not tighten.

g. Install a *kit* 10mm x 190mm bolt (125), a *kit* 3/8" washer (123), an outside support bracket (115) with the middle bolt, lockwasher (120), and a *kit* nylock nut (126) in the next mounting pad (119). Do not tighten.

h. Install a *kit* 7/16" x 7" bolt (122), a *kit* 3/8" washer (123), and a *kit* nylock nut (124) in the next mounting pad (119). Do not tighten.

i. Install a *kit* 12mm x 210mm bolt (127) and a *kit* 7/16" washer (123) in the last mounting pad (119). Do not tighten.

j. Install a *kit* outside support extension bracket (128) on the body (88) with two washers (113), lockwashers (114), and bolts (112).

k. Lower the body (88) on the *kit* spacer blocks.

2. Install the body driver's side spacer blocks.

a. Repeat steps C. 1. a. through k. for the body driver's side.

3. Finish the body spacer block installation.

a. Install two *kit* outside support extension brackets (128) on the stock outside support brackets (115) with two *kit* 5/16" x 1" bolts (129), four *kit* 5/16" SAE washers (130), and two *kit* 5/16" nylock nuts (131) on each side of the body (88) and the frame (25). Tighten to 19 lb-ft.

b. Remove 10 body mounting bolts (122, 125, and 127) one at a time, coat threads with Loctite®, and reinstall. Tighten to 55 lb-ft.

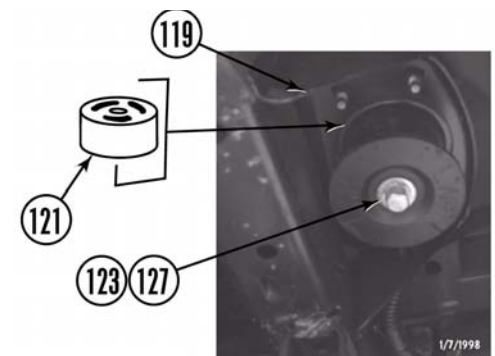
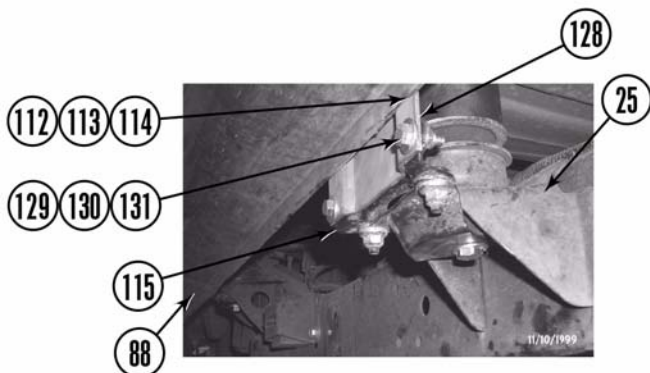
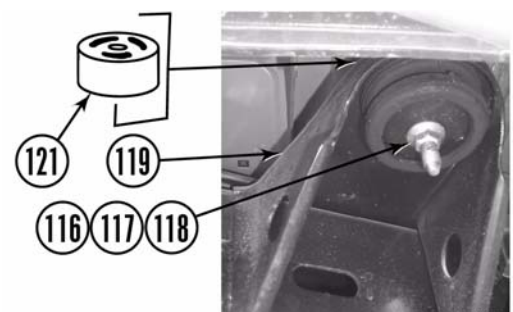
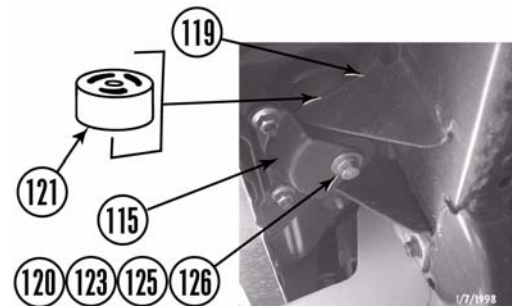
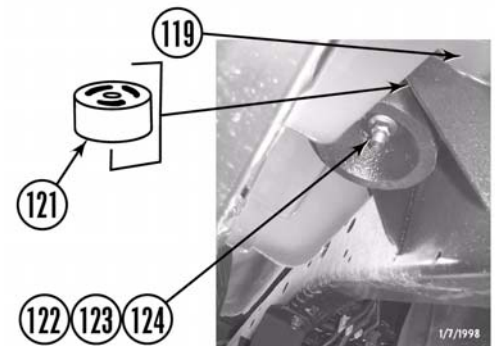
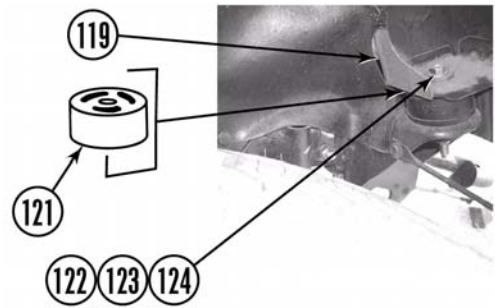

4. Install the steering extension.

**⚠WARNING**

Failure to properly install steering extension could result in loss of steering, causing serious personal injury and damage to the vehicle.

a. Install steering extension (132) in the lower coupler (18) of the steering shaft (16). Ensure steering extension is positioned so the stock retaining bolt (22) will install across the steering extension flat. Install retaining bolt in the steering shaft (16). If retaining bolt will not easily slide across the flat, the extension is installed incorrectly. Do not tighten.

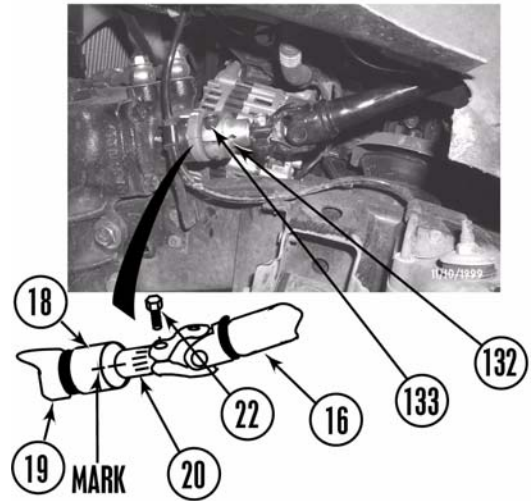

b. Extend the mark on the lower part of the steering shaft (16) down onto the steering extension (132). Install the upper part of the steering shaft (16) in the upper coupler (17). Ensure the marks are aligned.

c. Coat threads of retaining bolts (21, 22, and 133) with Loctite®.

d. Install stock retaining bolt (21) in the upper coupler (17).

e. Align the mark on the steering extension (132) with the mark on the gearbox (19). Install the steering extension on the gearbox splined shaft (20) with the *kit* retaining bolt (133). Do not tighten.

f. Ensure all marks are aligned and there is ample engagement at all unions. Tighten retaining bolts (21, 22, and 133).

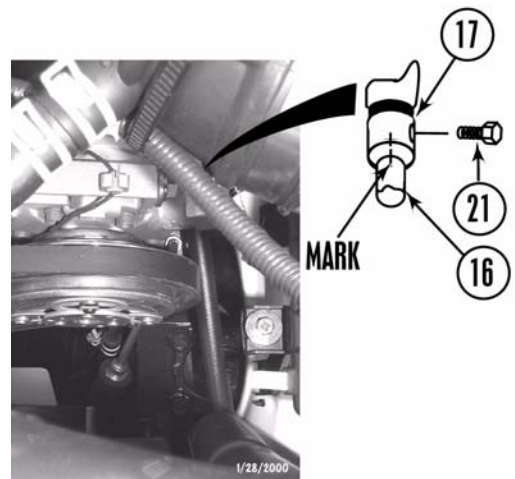

5. Install a/c hose (51) on the firewall (52) with two bolts (50).
6. Install two heater hoses (48) on the heater core (49) and tighten two clamps (47).

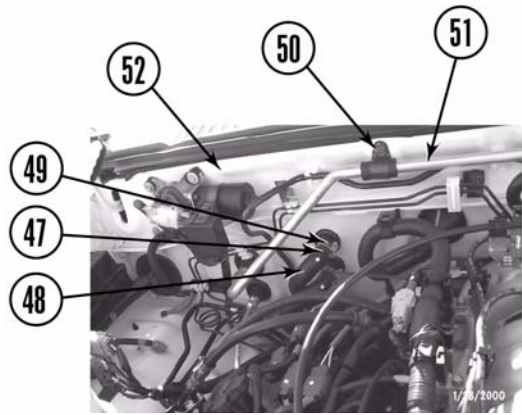

7. Install the brake line and vacuum lines.
  - a. Refer to the diagram from step A. 8. b. and install the brake line (67) and vacuum lines (68) on the passenger side frame rail (25) with two *kit* brackets (134), four screws (65), and two *kit* washers (135) and nuts (136). Ensure there is ample slack.
  - b. Install the line guard (64) on the passenger side frame rail (25) with two screws (63).

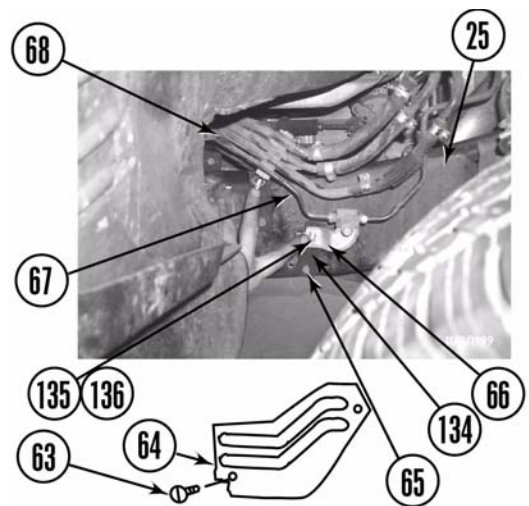

8. Install the radiator.

**NOTE**

After you cut metal away from the lower radiator support, you may want to prime and paint the affected area to avoid the possibility of rust forming.

a. Using a die grinder or hacksaw, cut away the stock lower radiator support (46) from the core support (37). Be especially careful of the a/c condenser (137) when cutting. Cut to the outside of each mounting hole approximately 1 1/2" to 2" and flush with the vertical surface of the core support. Allow enough room for the radiator to slide past the remaining sheet metal.

b. Using *kit* lower radiator support (138) as a template, mark the core support (37) for alignment. Align the holes in *kit* radiator support with the stock mounting holes. Mark the core support for proper alignment after the stock lower radiator support (46) has been removed.

c. Position *kit* lower radiator support (138) on the core support (37). Ensure *kit* support is aligned with the marks and flush against the core support, lip resting on the top.

d. Using the *kit* lower radiator support (138) as a template, mark the top of the core support (37) through the holes and remove.

e. Drill a 5/16" hole at each mark.

f. Install *kit* lower radiator support (138) on the core support (37) with two *kit* 1/4" x 1" bolts (139), four *kit* 1/4" washers (140) and two *kit* 1/4" nylock nuts (141). Do not tighten.

g. Position radiator (29) on the *kit* lower radiator support (142).

h. Remove two rubber bushings (142) from the plastic studs (143) on the radiator (29) top.

i. Position two rubber bushings (142) in the large holes in two *kit* 2" x 3" x 1" rectangular tubes (144) and slide the tubes on the plastic studs (143).

j. Install two top radiator mounts (45) on the tubes (144) with two *kit* 3/8" x 1" bolts (145), *kit* 3/8" USS washers (146), and *kit* 3/8" nylock nuts (147). Do not tighten.

k. Ensure radiator (29) is secure and tighten all radiator mounting hardware (139 and 141, 145 and 147).

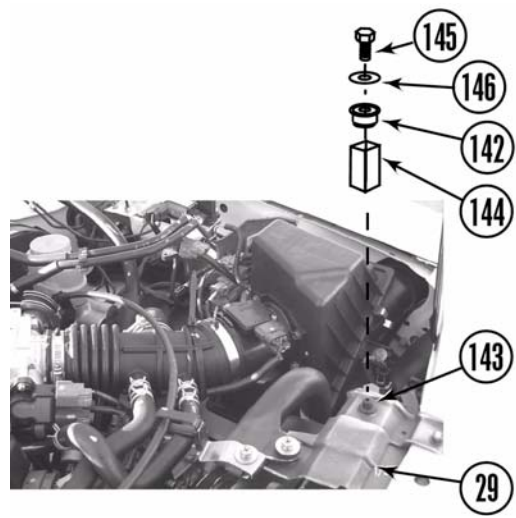
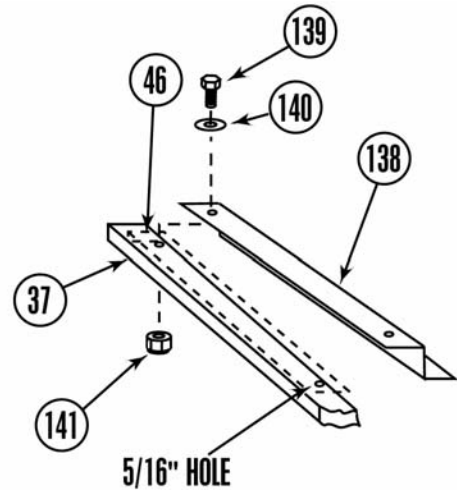

l. Install fan shroud (43) on the radiator (29) with four bolts (42). Check the fan to fan shroud clearance to ensure fan cannot make contact with the fan shroud.

m. Install upper radiator hose (33) on the radiator (29) and tighten clamp (32).

n. Install overflow bottle (36) on the core support (37) with two bolts (35). Tighten clamp (34).

o. Install intake damper (41) on the core support (37) with washer (40), lockwasher (39), and screw (38).

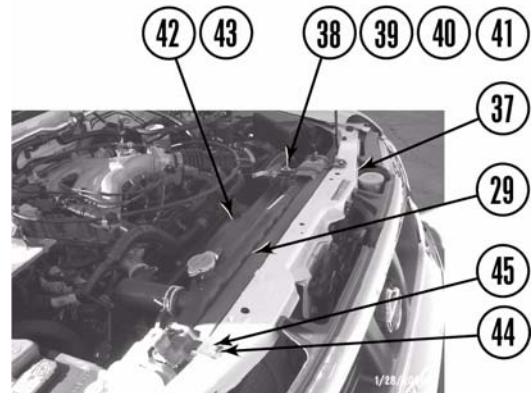

p. Bend a/c hose (51) firewall mounting bracket (148) forward to a 45-degree angle. This should give the line ample slack. If the line still feels tight, carefully bend the steel portion of the line to gain more slack.

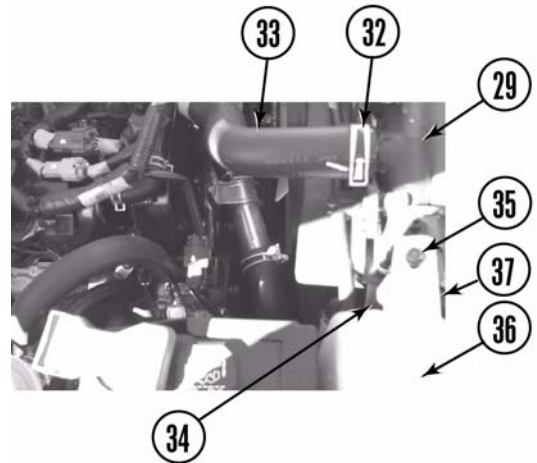

q. Check the a/c hose (51) at the core support (37). Ensure there is enough slack in the line to install. If not, remove bolt (149) and carefully bend the line. Install the a/c hose on the core support with the bolt.

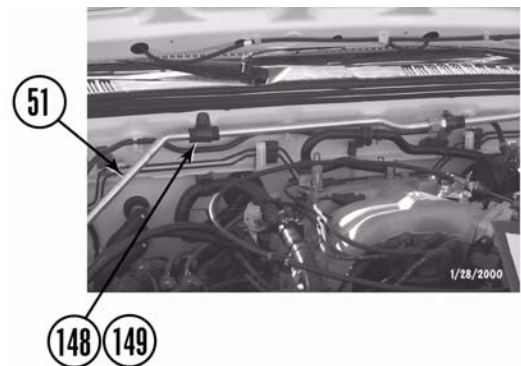

r. Check the a/c hose (51) at the AC pulley (150). Ensure line the pulley is not rubbing on the hose. If the pulley is rubbing, carefully bend the steel portion of the line to gain more clearance.

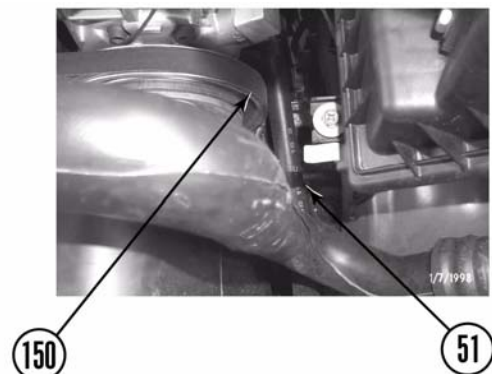

- s. Install rubber flap (24) on frame (25) with six panel clips (23).
- t. Install lower radiator hose (31) on the radiator (29) and tighten clamps (30).
- u. If removed, install skid plate (29) on frame (25) with six screws (27) and panel clips (28).
- v. Fill the cooling system as much as possible. Radiator (29) must be topped off later after the vehicle has been started.

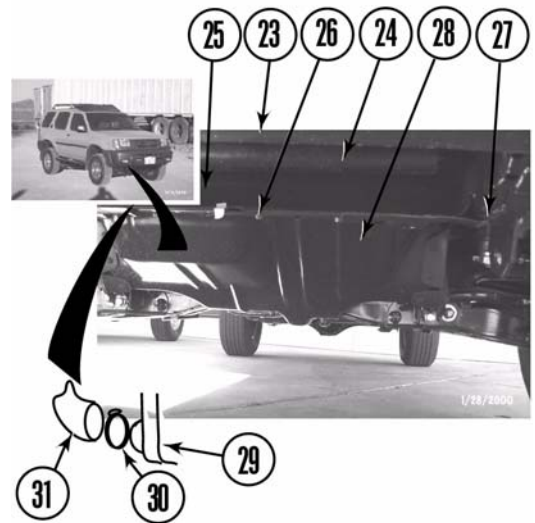

**NOTE**  
 It may be necessary to bend body safety loop slightly to align with the floorboard mounting holes.

- 9. Install the body safety loop (71) on the floorboard (72) with two *kit* 3" tubes (151), *kit* 3/8" washers (152), and *kit* 10mm x 1.25 x100" bolts (153). Tighten to 30 lb-ft.

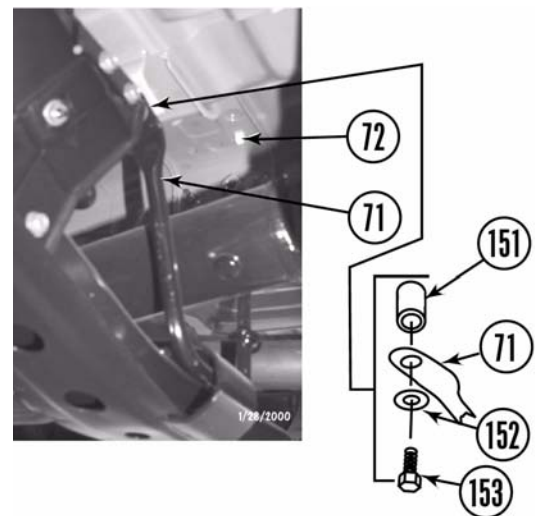

**⚠WARNING**

Use extreme caution when working near fuel lines and fuel tank. Clean up spilled fuel immediately. Any spark could cause an explosion or fire resulting in serious personal injury, death, and damage to the vehicle.

10. Lengthen and install the fuel filler hose.

- a. Loosen two clamps (154 and 155) on the filler hose (156), vent hose (157), and the fuel tank (158).
- b. Remove three bolts (159) and the filler neck and hose assembly from the passenger side rear wheel well (108).

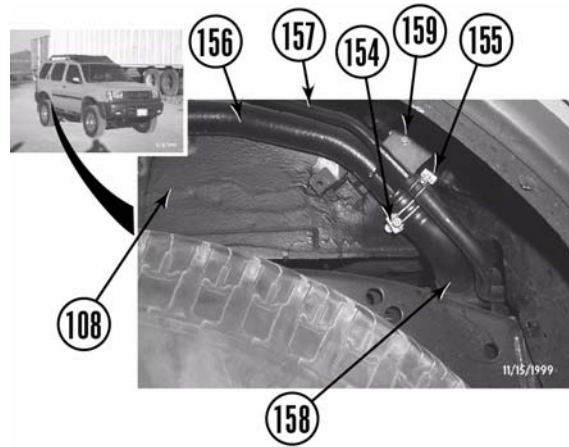

- c. Cut filler hose (156) toward the bottom below the first bend as shown.
- d. Install *kit* 1 3/4" fuel filler extension (160) between the two cut sections with two *kit* #28 clamps (161) at each end of the extension.
- e. Remove vent hose (157) and install the *kit* vent hose (162) with a *kit* #10 clamp (163).

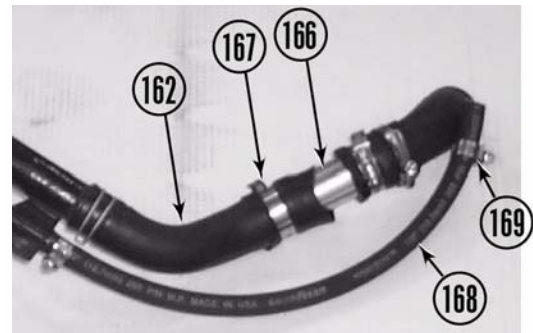

- f. Position filler neck and hose assembly in the passenger side rear wheel well (108) and install the filler hose (156) on the fuel tank (158) with the clamp (154). Do not tighten.
- g. Install *kit* vent hose (162) on the fuel tank (158) with a *kit* #10 clamp (163). Do not tighten.
- h. Install filler neck and hose assembly on the passenger side rear wheel well (108) with three bolts (159). Tighten clamps (154 and 163).

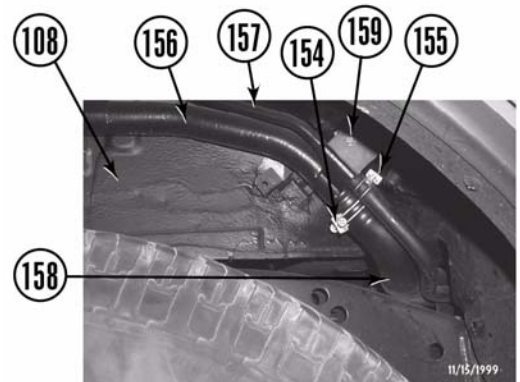

- i. Install filler hose guard (107) on the passenger side rear wheel well (108) with four panel clips (106).

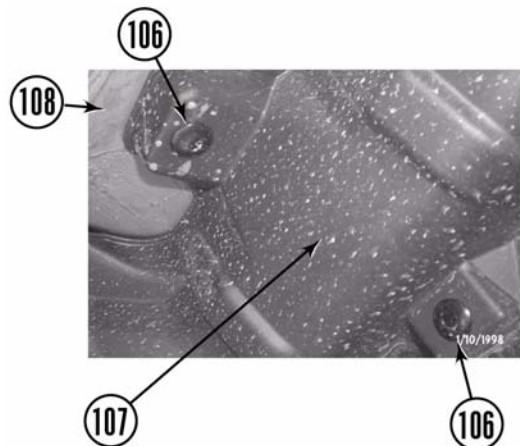

**⚠WARNING**

Be careful not to damage any of the parts attached to the shift levers during cutting and welding or damage to the equipment could result. A certified welder should perform all welding.

11. Lengthen and install the transmission shift lever and the transfer case shift lever.

a. Scribe a line along the side of the transmission shift lever (97) below the bend as shown. Cut the lever into two pieces through the line and deburr as necessary.

b. Position *kit* transmission shift lever extension (164) between the two pieces of the transmission shift lever (97), tapered end toward lever bottom. Ensure lever is all the way in and the extension and lever scribe lines align.

c. Using the holes in the extension as a guide, drill one 1/8" hole through each part of the transmission shift lever (97) and the opposite side of the extension (164).

d. Install two *kit* 1/8" x 1" roll pins (165) in the holes.

e. If removed, scribe a line along the side of the transfer case shift lever (99) (above the two bottom bends) as shown. Cut the lever into two pieces through the line and deburr as necessary.

f. Position *kit* transfer case shift lever extension (166) between the two pieces of the transfer case shift lever (99). Ensure the extension and lever scribed lines align and weld the extension in place.

g. Position transmission shift lever (97) in the top of the transmission (94). Ensure lever is all the way in and install the spacer (96) and c-clip (95).

h. Install transfer case shift lever (99) on the transfer case (100) with the bolt (98).

i. Check transmission shift lever and transfer case shift lever operation. Ensure there is complete engagement in all gears and ranges. If necessary, adjust the linkages (refer to the factory repair manual).

j. Install the shift boot (93) and console cover (92) on the floorboard (72) with four screws (91). Check transmission shift lever and transfer case shifter operation again.

k. Return the carpet and mat to its original position and install four scuff plates (85 and 86) on door jambs (87) with 12 screws (84).

l. Install two kick panels (90) on floorboard (72) with two bolts (89).

m. Position rear seat base (110) on floorboard (72) and engage four releases (109).

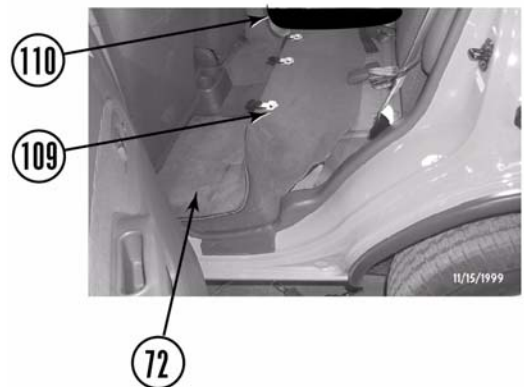
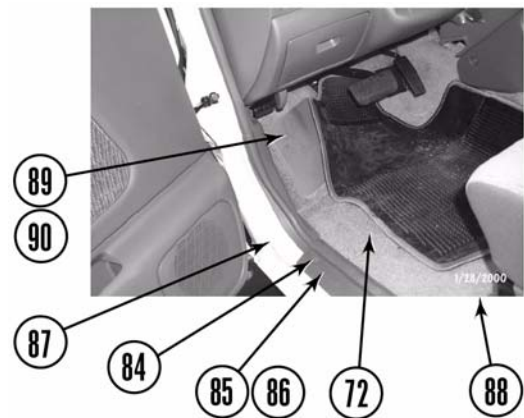
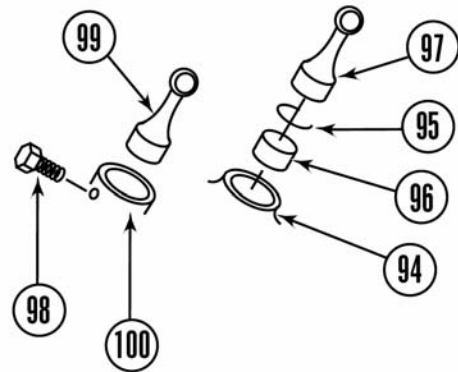
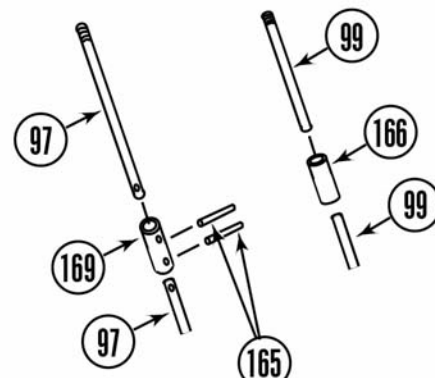



12. Install the front bumper.

a. Coat threads of twelve bolts (75, 77, and 80) and two *kit* 7/16" x 1" bolts (167) with Loctite®.

b. Install two *kit* front bumper relocating brackets (167) on the frame (25) with four washers (81) and bolts (80). Tighten the bolts enough that the brackets cannot move but the front bumper (78) can still be adjusted.

c. Position front bumper (78) on the *kit* relocating brackets (168) and install two *kit* 7/16" x 1" bolts (167), four *kit* 7/16" USS (large) washers (169), and two *kit* 7/16" nylock nuts (170). Do not tighten.

d. Install two bolts (77) in the front bumper (78) and front fenders (79). Do not tighten.

e. Adjust bumper to body clearance and tighten eight bolts (77, 80, and 167) to 55 lb-ft.

f. Install two front bumper supports (76) on frame (25) with two bolts (75). Tighten to 30 lb-ft.

**NOTE**  
Wheel well flaps may not reinstall in frame with panel clips. Because of the lift, you may have to reattach with zip ties.

g. Install two wheel well flaps (83) on the frame (25) with four panel clips (82).

h. If removed, connect two wire harness connectors (73) to the driving lights (74).

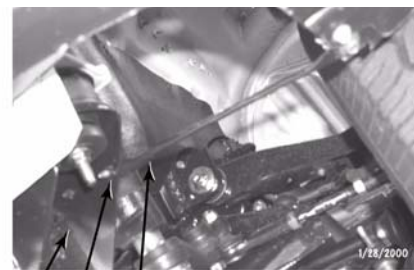
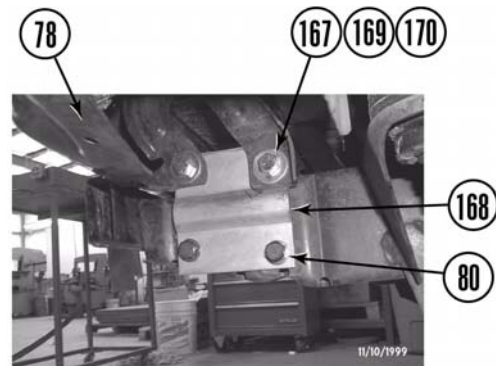
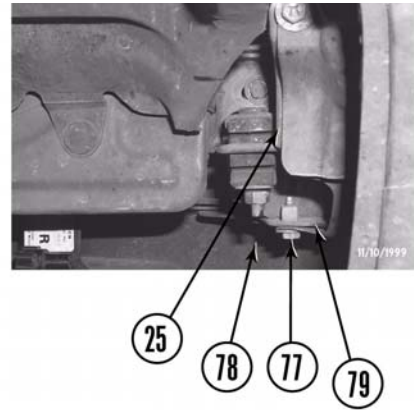

**⚠WARNING**

Raising the rear bumper is intended to enhance the appearance of the vehicle only. When raised, the rear bumper is no longer be rated for towing of any kind. Attempting to tow with the rear bumper after it has been raised can result in damage to the vehicle and possible personal injury. A class III receiver hitch must be installed to tow with the vehicle after the rear bumper has been raised.

13. Install the rear bumper.

- a. Notch rear bumper (102) in each side as shown. Measure in 3/4" from lip and cut a 5/8" wide by 1 1/8" deep notch.
- b. Protect bumper finish and slightly bend rear bumper inboard of notch as shown.
- c. Coat threads of six bolts (104) and six *kit* studs (171) with Loctite®.
- d. Install two *kit* rear bumper brackets (170) on the frame (25) with six nuts (172) on studs (171). Tighten nuts enough that the brackets cannot move but the rear bumper can still be adjusted.
- e. Install rear bumper (102) on two *kit* rear bumper brackets (170) with six bolts (104), lockwashers (105), and nuts (103). Tighten bolts enough that the brackets cannot move but the rear bumper can still be adjusted.
- f. Adjust the bumper to body clearance and tighten the nuts (172) and nuts (103) to 55 lb-ft.

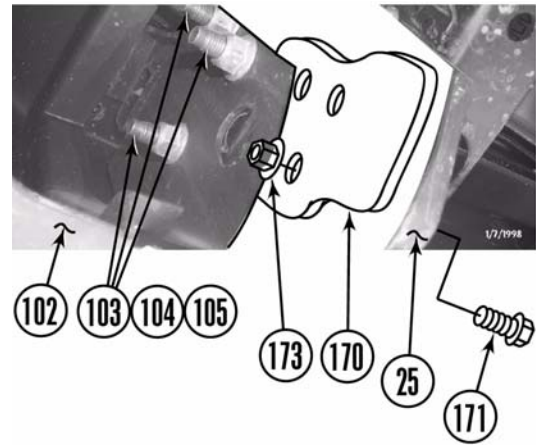
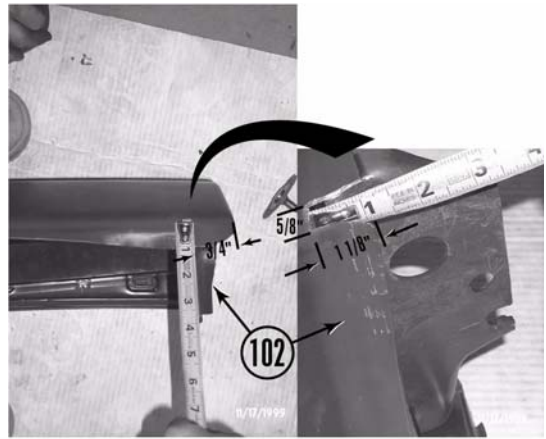

- g. Connect two license plate lights (101) on the rear bumper (102).

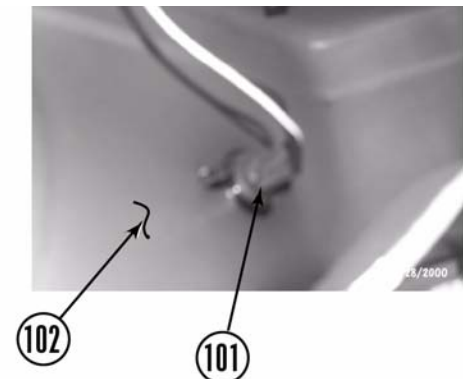

14. Install the air cleaner.

- a. Position air cleaner (13) and air duct (9) on throttle body (14) and intake (13) and tighten four clamps (10, 11, and 12).
- b. Install vacuum line (8) on air duct (9).
- c. Clamp four clips (7).
- d. Install *kit* zip tie (6).

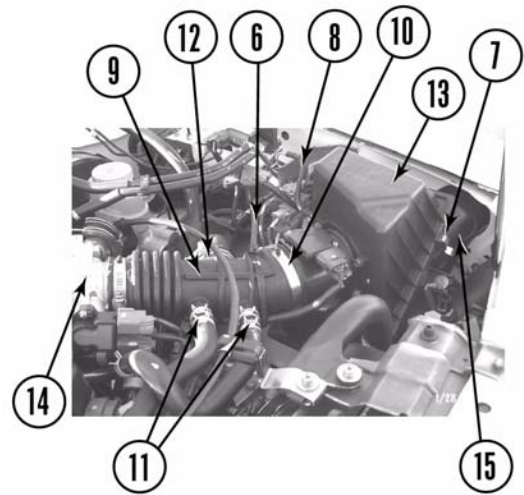

**D. After installation is complete.**

1. Install airbag fuse (4) in the fuse box (5).
2. Install battery (3) and connect both battery cables. Be sure to reconnect the positive cable (2) first, then the negative cable (1).
3. Stick *kit* warning sticker on the dash in plain sight of all vehicle occupants.
4. Double check the vehicle.

**⚠CAUTION**

Retorque all fasteners after 500 miles and after off road use. All body lift components should be visually inspected and fasteners retorqued during routine vehicle servicing.

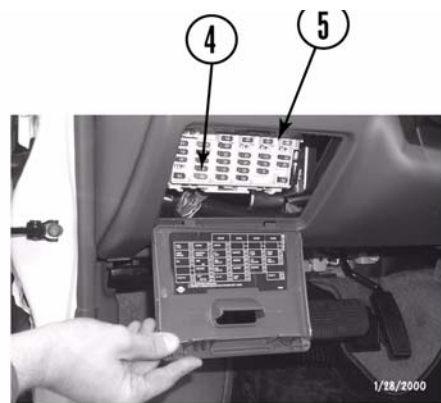

- a. Check all mounting hardware to ensure it is properly tightened.
- b. Check all wires, hoses, cables, etc. to ensure they have been properly connected and there is ample slack. With the number of hoses on this vehicle, it is vital that this be checked thoroughly.
- c. Check vehicle electrical system.
- d. Start vehicle and check the steering in both directions to ensure that there is no bind. Check clutch operation. Check the operation of the brake system and the parking brake. Check both shift levers' operation. Ensure that there is proper engagement in all gears and 4 wheel drive ranges.

**⚠CAUTION**

Never open a closed cooling system after the vehicle has been started. Only fill the cooling system if the cap has been removed while the vehicle was still cold.

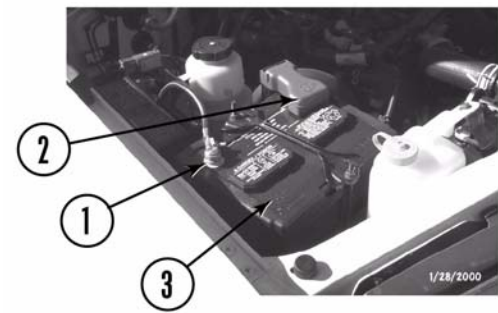

- e. Check coolant level. Fill coolant to the proper level (refer to the Owner's Manual).

f. Test drive vehicle in all gears and 4 wheel drive ranges. Pay close attention to all vehicle systems. Check all hardware again in 500 miles and as part of your regular maintenance schedule.

**⚠CAUTION**

Performance Accessories does not recommend any particular wheel and tire combinations for use with its body lifts and cannot assume responsibility for the customer's choice of wheels and tires. Reference your owner's manual for recommended tire sizes and warnings related to the use of oversized tires. Larger wheel and tire combinations increase stress and wear on steering and suspension components, which leads to increased maintenance and higher risk for component failure. Larger wheel and tire combinations also alter speedometer calibration, braking effectiveness, center of gravity, and handling characteristics. Consult with an experienced local off road shop to find what wheel and tire combinations work best with your vehicle.

**⚠NOTE**

All warranty information, instruction sheets, and other documents regarding the installation of this product must be retained by the vehicle owner. Information contained in the instructions and on the warranty card will be required for any warranty claims. The vehicle owner needs to understand the modifications made to his vehicle and how they affect vehicle handling and performance. Failure to provide the customer with this information can result in damage to the vehicle and severe personal injury.

## E. Kit Parts List.

Quantity	Description
1	Transmission shifter extension
2	Front bumper brackets
2	Rear bumper brackets
1	Lower radiator support bracket
2	Upper radiator brackets
2	Outside cab support brackets
1	Power steering reservoir bracket
1	1 3/4" x 3" fuel-filler extension
1	1/2" x 19" fuel vent hose
1	Warning to driver sticker
1	Logo label
10	3 x 3 blocks
1	6ml bottle Loctite® 262
2	1/8" x 1" roll pins
1	instructions booklet
1	Bolt pack BP40013
	6 7/16" x 7" bolts
	2 10mm x 190mm bolts
	2 12mm x 210mm bolts
	2 7/16" USS washers
	8 3/8" USS washers
	6 7/16" nylock nuts
	1 se 9000 steering extension
	1 3/8" x 1 1/4" socket head bolt
1	Hardware Pack HP40013
	<b>Bolts</b>
	4 7/16" x 1" bolts
	2 10mm x 1.25 x 100mm bolts
	2 3/8" x 1" bolts
	4 5/16" x 1" bolts
	5 1/4" x 1 " bolts
	<b>Washers</b>
	8 7/16" USS washers
	6 3/8" USS washers
	6 1/2" USS washers
	8 5/16" SAE washers
	12 1/4" SAE washers
	<b>Nuts</b>
	4 7/16" nylock nuts
	2 3/8" nylock nuts
	6 1/2" nylock nuts
	4 5/16" nylock nuts
	7 1/4" nylock nuts
	<b>Miscellaneous</b>
	2 #10 hose clamps
	2 #28 hose clamps
	2 zip ties
	2 3/8" sched 40 pipe UP3-10
	1 1/2 x 3" rod
	2 groundstraps with stud UP3-3

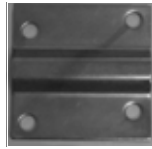

Front bumper bracket



Lower radiator bracket

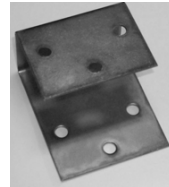

Power steering reservoir bracket

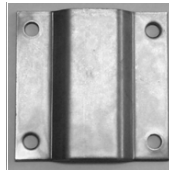

Outer cab support straps